

### FEATURED MODEL

440276 Large, 12" bowl depth

### ADDITIONAL MODELS

440274 Large, 8" bowl depth

440278 Large, 10" bowl depth

### FEATURES

- Required outside cabinet: 36"
- 18 gauge, 304 series stainless steel
- Premium 18/8 chrome/nickel content
- Satin Finish
- Sound deadening insulation
- 4 diagonal drain grooves channel water directly to center drain
- Straight bowl sides with 1-1/2" cutout corner radius

### OPTIONAL ACCESSORIES

Stainless Steel Sink Grid: 220997

### CODE/STANDARDS COMPLIANCE

ASME 112.19.3-00

IAPMO/UPC listed



### NOMINAL DIMENSIONS

Model 440276 shown

OVERALL	CUT OUT SIZE	BOWL DEPTH	DRAIN
33" x 22"	32-1/4" x 21-1/4"	12"	3-1/2"

DXF cutout templates available on our website.

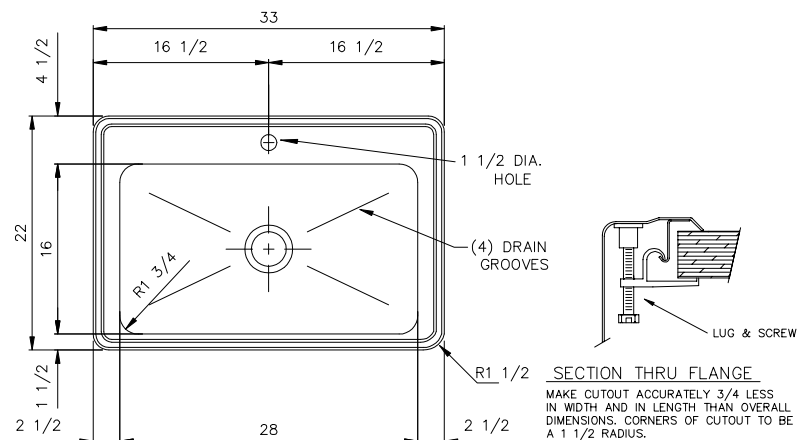

### WARRANTY

Blanco America's Stainless Steel sinks feature a LIMITED LIFETIME WARRANTY to be free of all manufacturing defects under normal use. See our complete warranty for details.

While Blanco America endeavors to provide accurate information, all dimensions are nominal, cannot be guaranteed, and are subject to change or cancellation. Blanco America assumes no responsibility for use of superseded or voided specifications.

### JOB INFORMATION

Job Name: \_\_\_\_\_

Contact: \_\_\_\_\_

Date Specified: \_\_\_\_\_

Specifier: \_\_\_\_\_

Contractor: \_\_\_\_\_

### KNOCKOUT HOLE LOCATIONS

Pre-drilled for three faucet holes.

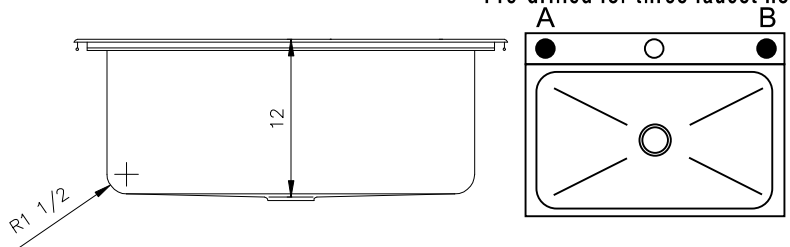

**BLANCO AMERICA**

800.451.5782

www.blancoamerica.com

© 2013 BLANCO AMERICA

7/13

SPEC-003